

THE RESTORED CHURCH OF GOD®

CHILDREN'S BIBLE LESSONS

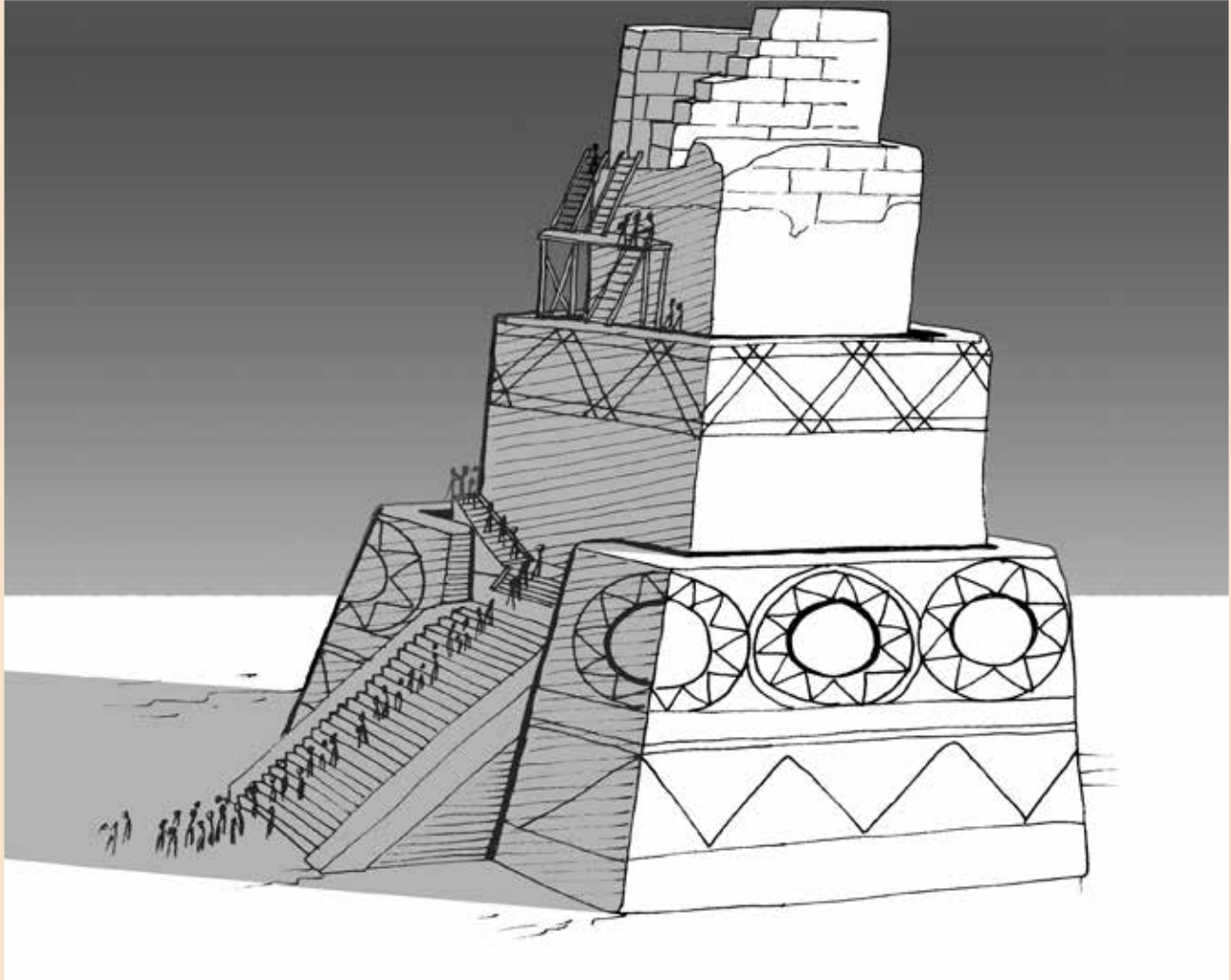

The Tower of Babel

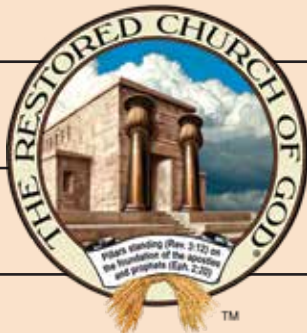

LEVEL K
LESSON 5

The Tower of Babel

After the Flood, Noah's three sons had large families. The number of people on Earth grew large. Noah's son Ham had a son named Cush. Cush had a son named Nimrod.

Nimrod grew up to be a mighty hunter and leader. People looked up to him because he protected them.

But Nimrod did not obey God. He focused on himself. He led people to worship false gods like the sun and snakes. The people followed Nimrod.

Nimrod made plans to build a large tower. The people helped him to build this tower.

God was not pleased with the people. They would not obey His Laws.

Nimrod was a mighty hunter.



Following Nimrod, the people worshipped false gods.

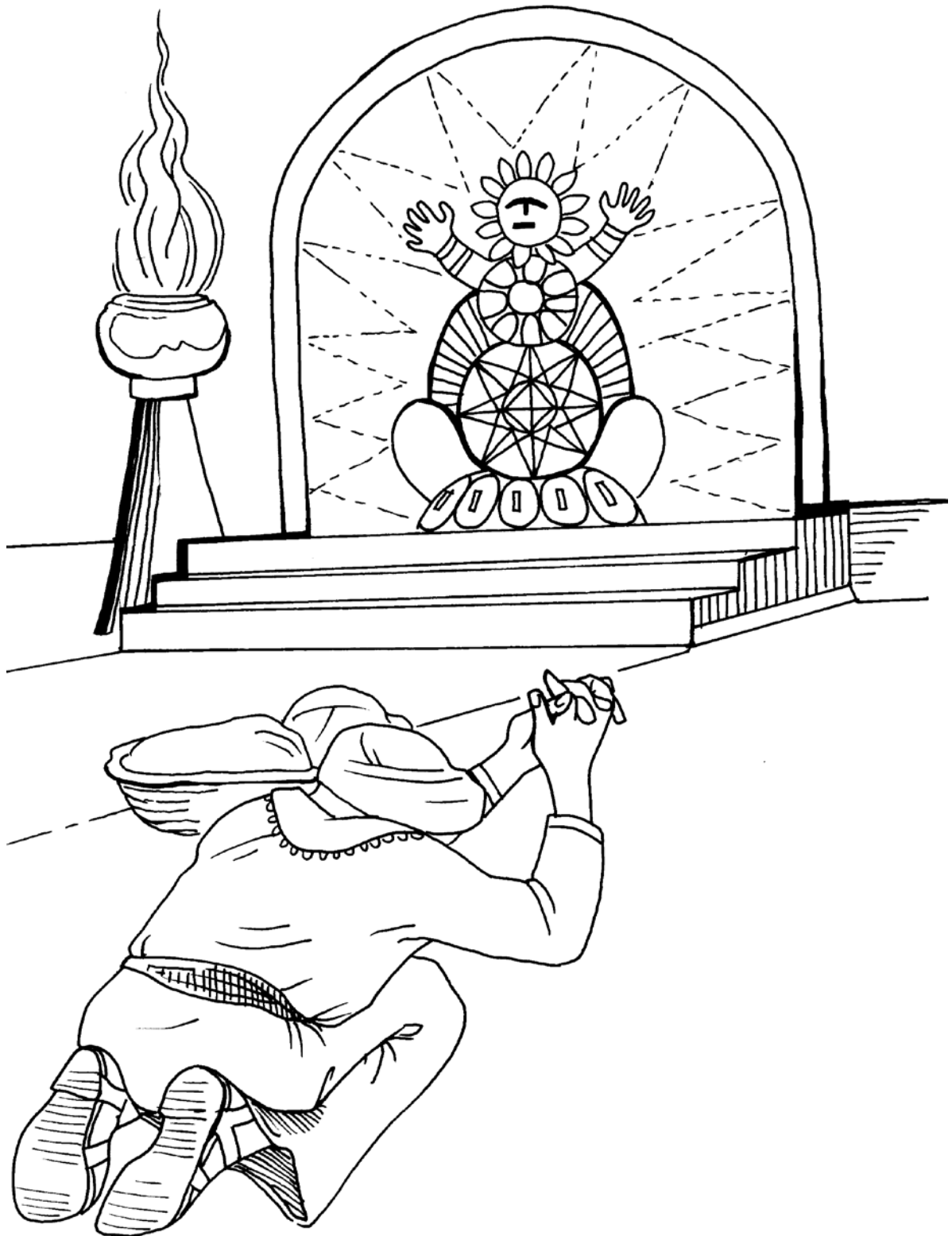

The Tower of Babel

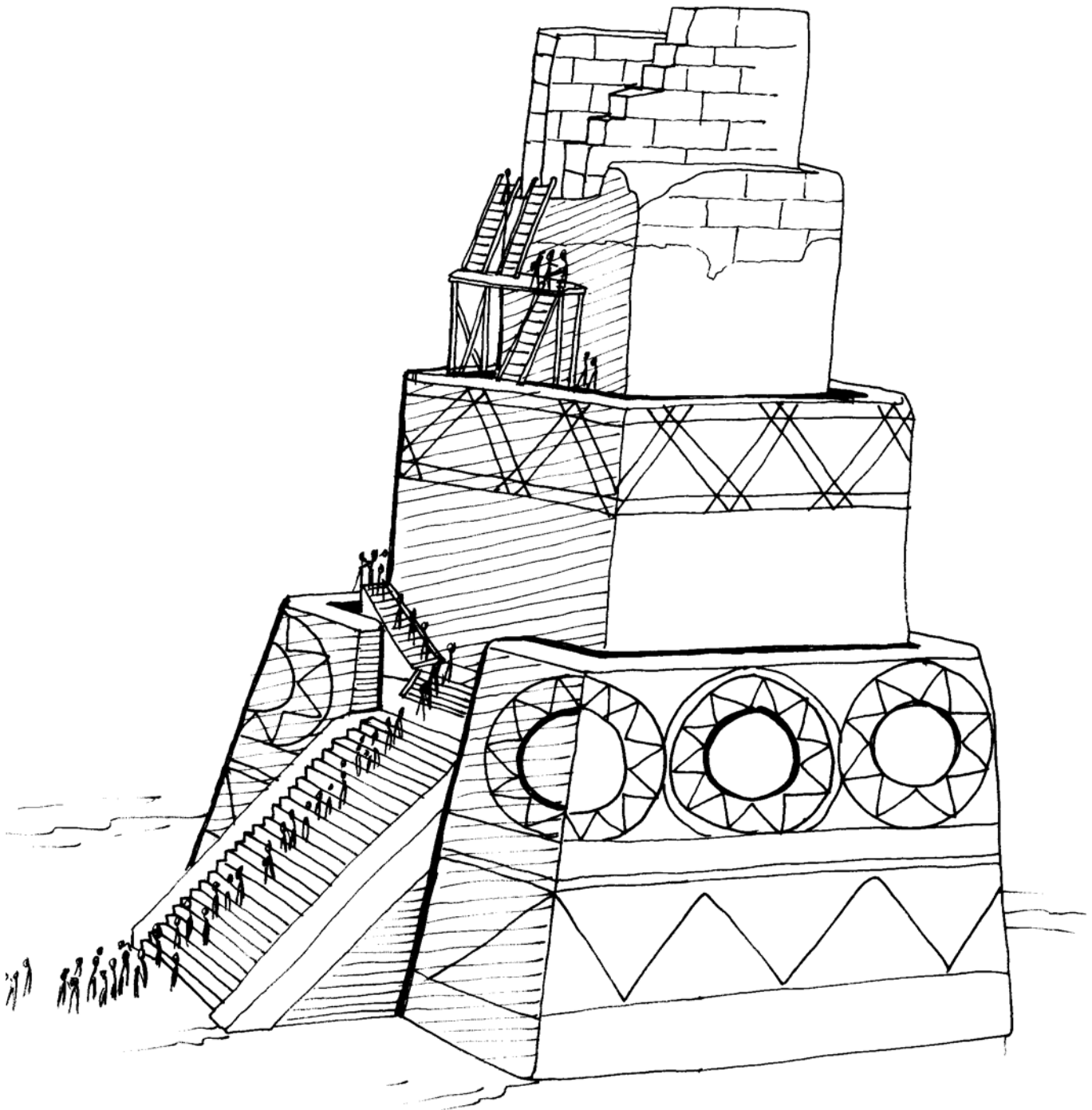

Parents: Explain to your children that the Tower of Babel was a symbol of rebellion against God.

CONNECT THE DOTS

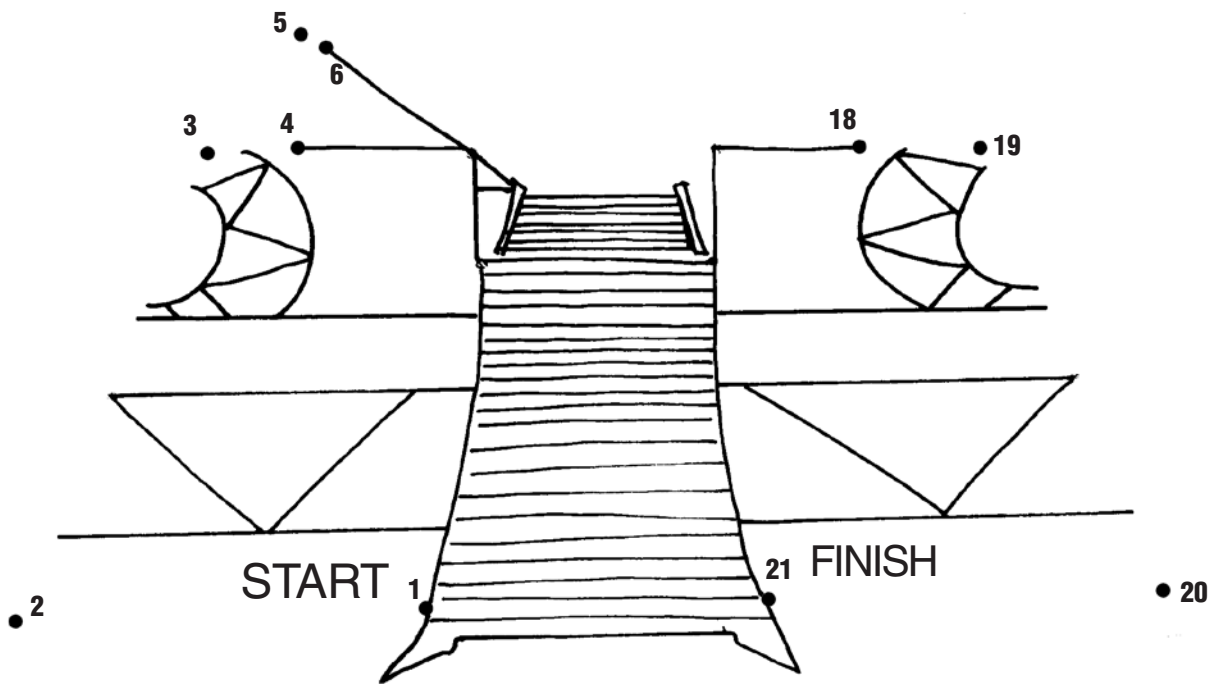
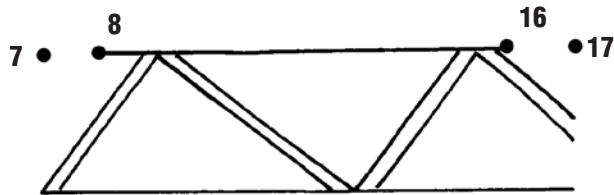
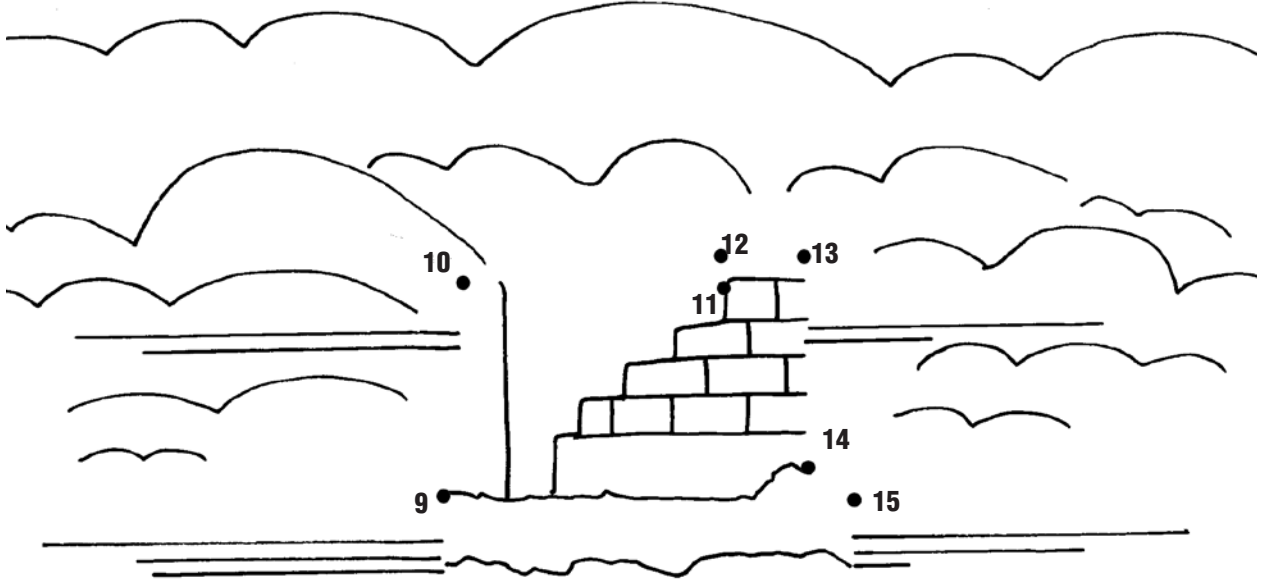

God changed the people's language.



Parents: Explain that God knew that under Nimrod's rule, the people would become evil like before the Flood. Therefore, He caused them to speak different languages, so they could not understand each other. This caused confusion. Babel means confusion. This is why it is called the Tower of Babel.

MAZE

Show the man how to get to the top of the Tower of Babel, so he can place the brick there.



Start

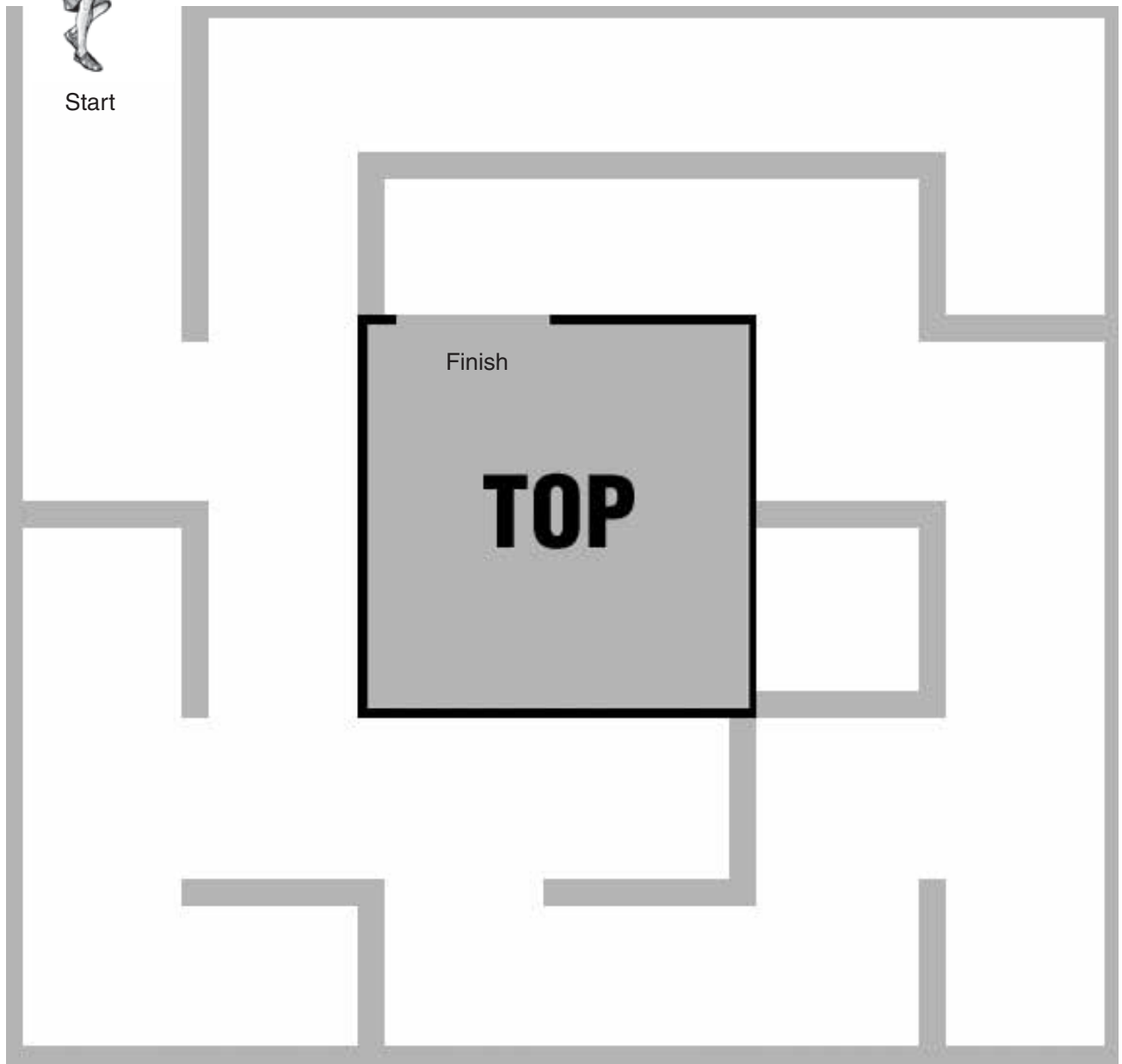

FILL IN THE BLANKS

1. _____ was a great hunter, who protected his people from wild animals.
2. Nimrod did not obey _____.
3. Nimrod led the people to worship _____ gods.
4. God confused the people's _____ . As a result, work on the tower stopped.

No one could understand what others were trying to say. They could not finish the Tower of Babel.

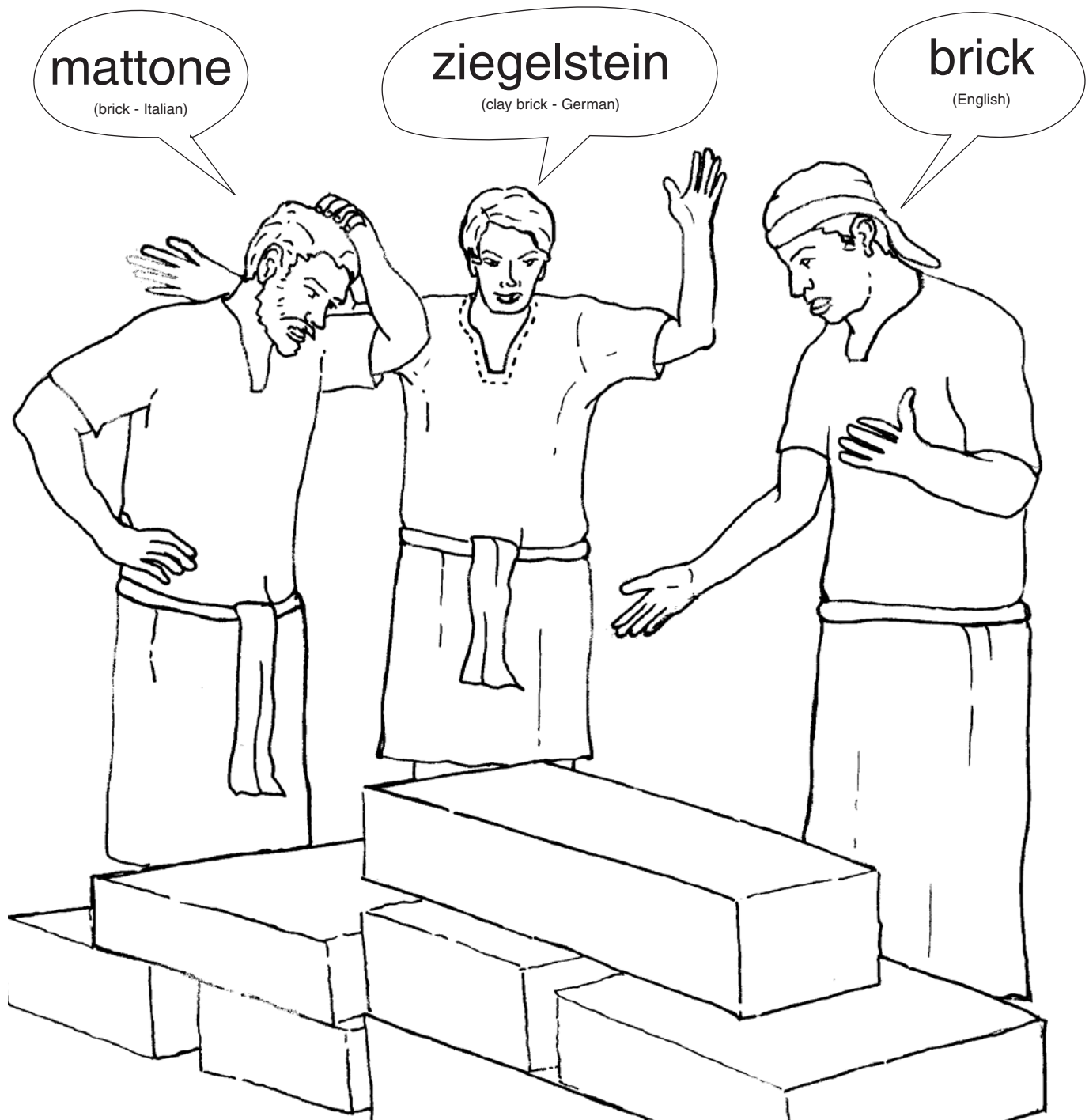

Families left the city and settled in other parts of the world.

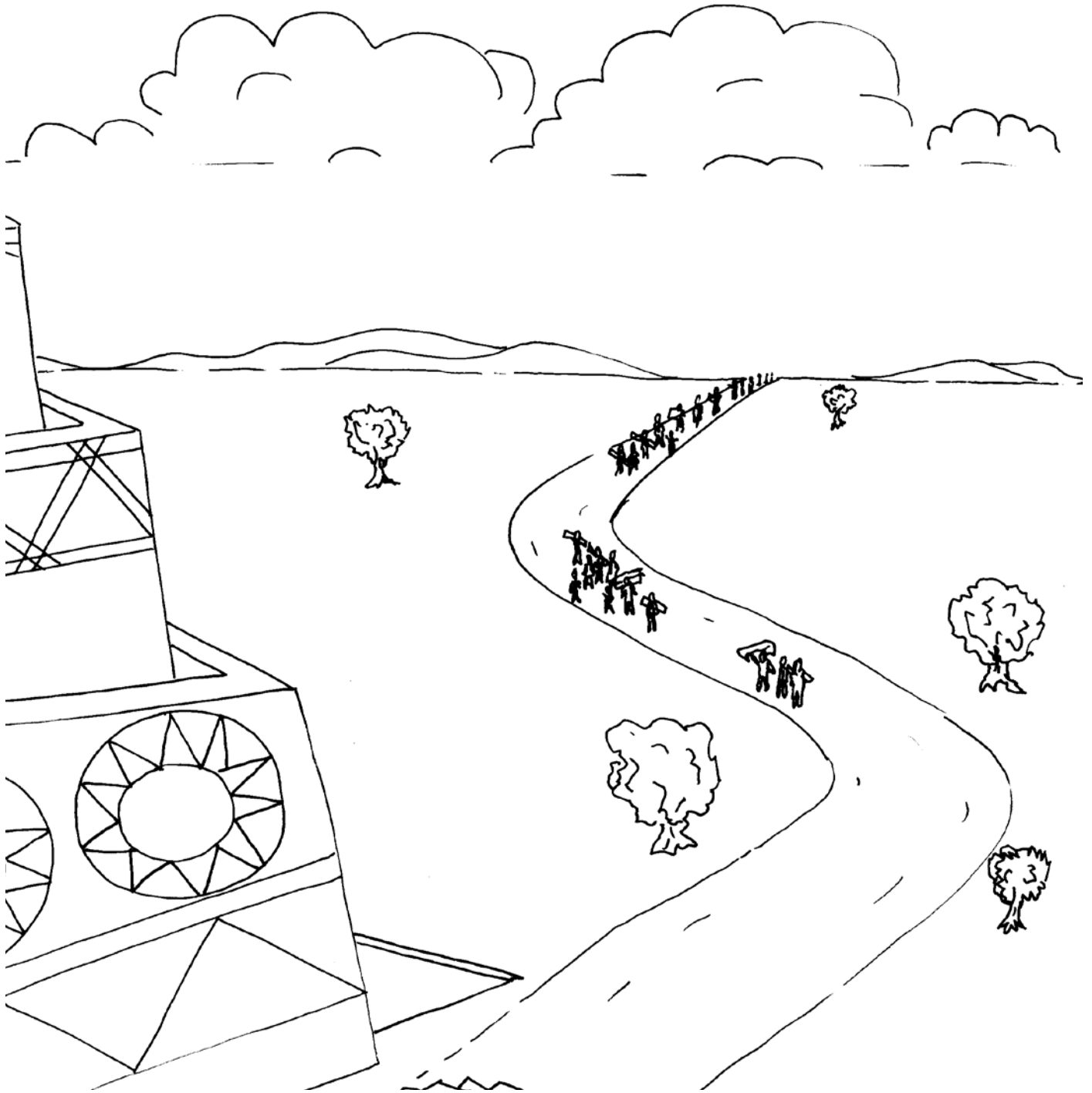

BIBLE MEMORY: Genesis 11:9

